

## VIA DURINI

Maurizio Di Mauro - 2016



### DESCRIPTION

Lighthearted and original, spacious and welcoming: Via Durini is a chest of drawers with multiple personalities that, as such, are ready to adapt to the peculiarities of yours. Its three drawers draw original lines, creating a body supported by a particular solid wood foot: you can obtain many combinations varying its legs, structure and front of the drawers. Have fun discovering how its mood changes just reversing its lacquered and wooden finishing between the front and the top: from a bold chest of drawers you'll get a more traditional one.

### TECHNICAL INFORMATION

#### Typology

Chest of drawers

#### Legs

Solid walnut | Solid ash open-pore

#### Outside structure

MDF panel lacquered | ebony or canaletto veneer

#### Frontal drawer

MDF panel lacquered | ebony veneer

#### Inside drawer

Ash open-pore veneered

#### Handle

Metal finish MC chrome | painted metal

#### Dimensions

cm 138(top 130)x52x85h. | in 54"1/3(top 51"1/6)  
x20"1/2x33"1/2h

### DESCRIZIONE

*Giocoso e originale, spazioso e accogliente: Via Durini è un comò dalle personalità molteplici che, in quanto tale, è pronto ad adattarsi alle peculiarità della tua. I suoi tre cassetti disegnano linee originali, formando un corpo sostenuto da un particolare piedino in legno massello: tantissime combinazioni si possono ottenere variando le sue gambe, la struttura e i frontale dei cassetti. Divertiti a scoprire come il suo mood riesce a cambiare anche solo invertendo il finishing laccato e in legno tra il frontale e il top: da comò eccentrico a tradizionale.*

### DESCRIZIONE TECNICA

#### Tipologia

Comò

#### Gambe

Massello di noce canaletto | Massello di frassino poro aperto

#### Struttura esterna e frontale cassetto

Pannello di fibra a media densità laccato  
 Impiallacciato con essenza ebano o canaletto

#### Frontali cassetti

Pannello di fibra a media densità laccato  
 Impiallacciato con essenza ebano

#### Interno cassetti

Impiallacciato frassino poro aperto

#### Maniglia

Metallo in finitura MC cromo | metallo verniciato

#### Dimensioni

cm 138(top 130)x52x85h

**VIA DURINI**

Maurizio Di Mauro - 2016

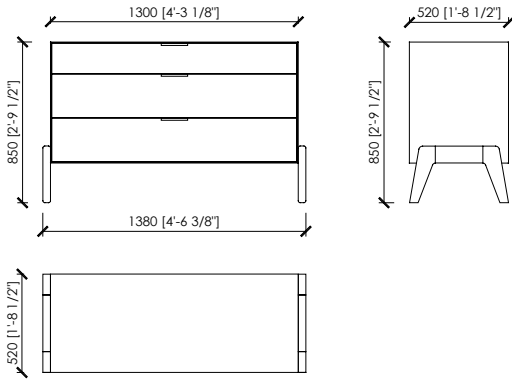

**EXTERNAL STRUCTURE FINISHES - WOOD | FINITURA STRUTTURA ESTERNA - LEGNO**

CANALETTO WALNUT



only with matt and glossy lacquered frontal drawers | *solo con frontali cassetto laccati lucido o opaco*

matt

EBONY



only with matt ebony veneered frontal drawers | *solo con frontali cassetto impiallacciati ebano finitura opaca*

matt

EBONY



only with glossy ebony veneered frontal drawers | *solo con frontali cassetto impiallacciati ebano finitura lucida*

glossy

**HANDLES - METAL FINISHINGS | MANIGLIE - FINITURE METALLICHE**

MC CHROME

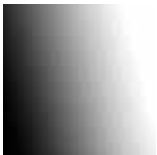

GREY

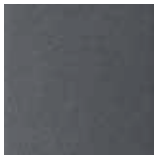

CHAMPAGNE



BLACK

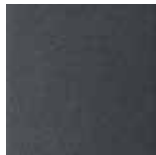

SATIN BRASS DARK



SATIN BRASS LIGHT



BRONZE



Printed colors are to be considered as indicative | *I colori stampati sono da considerarsi indicativi*

Dimensions in mm. MC Meroni & Colzani reserved the right to make change is reserved. This informations are based on the last price list.

Dimensioni in mm. MC Meroni & Colzani si riserva il diritto di apportare modifiche ai modelli senza preavviso. Le informazioni sono basate sull'ultimo aggiornamento del listino.

DATA SHEET  
V.1 2022

**VIA DURINI**

Maurizio Di Mauro - 2016

**EXTERNAL STRUCTURE FINISHES - MATT LACQUERED | FINITURA STRUTTURA ESTERNA - LACCATO OPACO**  
*only with MATT lacquered frontal drawers | solo con frontali cassetto laccato OPACO*



**EXTERNAL STRUCTURE FINISHES - GLOSSY LACQUERED | FINITURA STRUTTURA ESTERNA - LACCATO LUCIDO**  
*only with GLOSSY lacquered frontal drawers | solo con frontali cassetto laccato LUCIDO*



Printed colors are to be considered as indicative | I colori stampati sono da considerarsi indicativi

**VIA DURINI**

Maurizio Di Mauro - 2016

**LEGS FINISHES - WOOD | FINITURA GAME - LACCATO LEGNO**

CANALETTO WALNUT

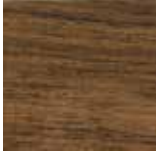

matt

OPTICAL WHITE ash



WHITE ash



PEARL ash



CARAMEL ash

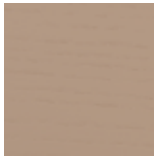

GREIGE ash



TOBACCO ash



LIGHT GREY ash



MUD ash



ANTHRACITE ash

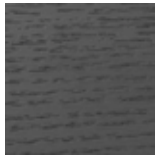

BLACK ash



DARK BROWN ash



RED ash



YELLOW ash



GREEN ash



TEAL ash



DARK BLUE ash

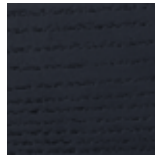

Printed colors are to be considered as indicative | I colori stampati sono da considerarsi indicativi

Dimensions in mm. MC Meroni & Colzani reserved the right to make change is reserved. This informations are based on the last price list.  
Dimensioni in mm. MC Meroni & Colzani si riserva il diritto di apportare modifiche ai modelli senza preavviso. Le informazioni sono basate sull'ultimo aggiornamento del listino.

DATA SHEET  
V.1 2022