



MOOREA

animovel
-TECHNIK-



Concept tables et chaises | Conceito mesas e cadeiras | Tables and chairs concept

MOOREA



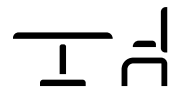

2200/3000X770X1000
LF-403 - BX-271



2200/3000X770X1000
LF-403 - BX-271





2200/3000X770X1000
LF-403 - BX-271

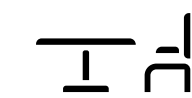













2000/2800X770X1000
LF-445 - C-S-01C503















2000/2800X770X1000
LF-445 - C-S-01C503





Ref.	Caractéristiques Características Characteristics					Finitions Acabamentos Finishes					Points Ponto Points			Informations supplémentaires Informações suplementares Additional information			
	Dimensions Dimensões Dimensions	Allonges Aumentos Extensions	Format Formato Form		Dessus Tampo Table top		Allonges Aumentos Extensions		Pied Pé Feet	BX	CM-S01	CM-S03	M³	Colis Volumes Packs	Poids Peso Weight	Eco taxe	
					BX	CM	BX	CM	LF								
631314	1800 x 770 x 1000	-	V2 	8	✓	✓	✗	✗	✓	77	94	107	0,819 m³	3	BX: 74 Kg CM: 85 Kg	BX: 01019010290 CM: 01019010290	
631315	2000 x 770 x 1000	-	V2 	10	✓	✓	✗	✗	✓	80	98	112	0,851m³	3	BX: 78 Kg CM: 91 Kg	BX: 01019010290 CM: 01019010290	
631316	2200 x 770 x 1000	-	V2 	10	✓	✓	✗	✗	✓	83	102	117	0,882 m³	3	BX: 83 Kg CM: 96 Kg	BX: 01019010290 CM: 01019010290	
631317	1800 x 770 x 1100	-	V2 	8	✓	✓	✗	✗	✓	80	-	109	0,847 m³	3	BX: 78 Kg CM: 91 Kg	BX: 01019010290 CM: 01019010290	
631318	2000 x 770 x 1100	-	V2 	10	✓	✓	✗	✗	✓	83	-	116	0,881 m³	3	BX: 83 Kg CM: 97 Kg	BX: 01019010290 CM: 01019010290	
631319	2200 x 770 x 1100	-	V2 	10	✓	✓	✗	✗	✓	86	-	121	0,916 m³	3	BX: 88 Kg CM: 103 Kg	BX: 01019010290 CM: 01019010290	
631327	1800 x 770 x 1000 ⁽¹⁾	1 x 800	V2 	10	✓	✓	✓	✓	✓	121	141	160	0,819 m³	3	BX: 95 Kg CM: 111 Kg	BX: 01019010290 CM: 01019080300	
631328	2000 x 770 x 1000 ⁽¹⁾	1 x 800	V2 	12	✓	✓	✓	✓	✓	123	145	166	0,851m³	3	BX: 100 Kg CM: 117 Kg	BX: 01019010290 CM: 01019080300	
631329	2200 x 770 x 1000 ⁽¹⁾	1 x 800	V2 	12	✓	✓	✓	✓	✓	125	149	172	0,882 m³	3	BX: 104 Kg CM: 123 Kg	BX: 01019010300 CM: 01019080300	
631330	1800 x 770 x 1100 ⁽¹⁾	1 x 800	V2 	10	✓	✓	✓	✓	✓	125	-	164	0,847 m³	3	BX: 102 Kg CM: 119 Kg	BX: 01019010300 CM: 01019080300	
631331	2000 x 770 x 1100 ⁽¹⁾	1 x 800	V2 	12	✓	✓	✓	✓	✓	128	-	170	0,881 m³	3	BX: 107 Kg CM: 126 Kg	BX: 01019010300 CM: 01019080300	
631332	2200 x 770 x 1100 ⁽¹⁾	1 x 800	V2 	12	✓	✓	✓	✓	✓	131	-	176	0,916 m³	3	BX: 111 Kg CM: 132 Kg	BX: 01019010300 CM: 01019080300	

Ref.	Caractéristiques Características Characteristics				Finitions Acabamentos Finishes					Points Ponto Points			Informations supplémentaires Informações suplementares Additional information			
	Dimensions Dimensões Dimensions	Allonges Aumentos Extensions	Formato Formato Form		Dessus Tampo Table top		Allonges Aumentos Extensions		Pied Pé Feet	BX	CM-S01	CM-S03	M³	Colis Volumes Packs	Poids Peso Weight	Eco taxe
					BX	CM	BX	CM	LF							
631311	1800 x 770 x 1000	-	V3 	8	✓	✓	✗	✗	✓	68	82	95	0,819 m³	3	BX: 75 Kg CM: 86 Kg	BX: 01019010290 CM: 01019080290
631312	2000 x 770 x 1000	-	V3 	10	✓	✓	✗	✗	✓	71	86	101	0,851 m³	3	BX: 79 Kg CM: 91 Kg	BX: 01019010290 CM: 01019080290
631313	2200 x 770 x 1000	-	V3 	10	✓	✓	✗	✗	✓	77	94	106	0,882 m³	3	BX: 83 Kg CM: 97 Kg	BX: 01019010290 CM: 01019080290
631324	1800 x 770 x 1000 ⁽¹⁾	1 x 800	V3 	10	✓	✓	✓	✓	✓	119	140	158	0,867 m³	4	BX: 102 Kg CM: 118 Kg	BX: 01019010300 CM: 01019080300
631325	2000 x 770 x 1000 ⁽¹⁾	1 x 800	V3 	12	✓	✓	✓	✓	✓	121	144	164	0,898 m³	4	BX: 106 Kg CM: 124 Kg	BX: 01019010300 CM: 01019080300
631326	2200 x 770 x 1000 ⁽¹⁾	1 x 800	V3 	12	✓	✓	✓	✓	✓	124	148	169	0,930 m³	4	BX: 111 Kg CM: 129Kg	BX: 01019010300 CM: 01019080300
631320	1800 x 770 x 1100	-	V3 	8	✓	✓	✗	✗	✓	88	-	117	0,847 m³	3	BX: 81 Kg CM: 97 Kg	BX: 01019010290 CM: 01019080290
631321	2000 x 770 x 1100	-	V3 	10	✓	✓	✗	✗	✓	91	-	123	0,881 m³	3	BX: 85 Kg CM: 104 Kg	BX: 01019010290 CM: 01019080290
631322	2200 x 770 x 1100	-	V3 	10	✓	✓	✗	✗	✓	93	-	127	0,916 m³	3	BX: 90 Kg CM: 110 Kg	BX: 01019010290 CM: 01019080300
631333	1800 x 770 x 1100 ⁽¹⁾	1 x 800	V3 	10	✓	✓	✓	✓	✓	127	-	166	0,894 m³	4	BX: 102 Kg CM: 119 Kg	BX: 01019010300 CM: 01019080300
631334	2000 x 770 x 1100 ⁽¹⁾	1 x 800	V3 	12	✓	✓	✓	✓	✓	130	-	171	0,929 m³	4	BX: 107 Kg CM: 125 Kg	BX: 01019010300 CM: 01019080300
631335	2200 x 770 x 1100 ⁽¹⁾	1 x 800	V3 	12	✓	✓	✓	✓	✓	133	-	176	0,963 m³	4	BX: 111 Kg CM: 132 Kg	BX: 01019010300 CM: 01019080300

Observations

1) Pour le dessus en céramique les allonges sont automatiquement en céramique.

Informations techniques

- Dessus de table plaqué chêne ou céramique
- Allonge de table plaquée chêne ou céramique
- Structure en bois massif en frêne
- Pieds en métal
- Ouverture central avec allonge synchronisée
- Allonges avec niveleur
- Système d'ouverture avec amortisseur.
- Prise de main en cuir facile pour ouverture d'allonge
- Coulisse Pöttker

Types dessus de table | Tipos de tampo de mesa | Types of table top

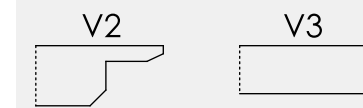

Observações

1) Para tampo em cerâmica os aumentos são automaticamente em cerâmica.

Informações técnicas

- Tampo em placa folheada a carvalho ou cerâmica
- Aumentos em placa folheada ou cerâmica
- Estrutura em madeira maciça de Freixo
- Pés em metal
- Abertura central com aumentos sincronizados
- Aumentos com niveladores
- Sistemas de abertura com amortecedores
- Puxador em pele para abrir os aumentos
- Corrediças Pöttker

Observations

1) For tables top in ceramic, the extensions are automatically in ceramic.

Technical informations

- Table top in wood fibreboard with veneered oak or ceramic
- Extensions in wood fibreboard with ceramic or veneered.
- Structure in wood ash
- Metal feet
- Central opening with synchronize extensions
- Extensions with levers
- Opening systems with dampers
- Leather pull handle to open extensions

MOOREA

Dimensions

Dimensões | Dimensions

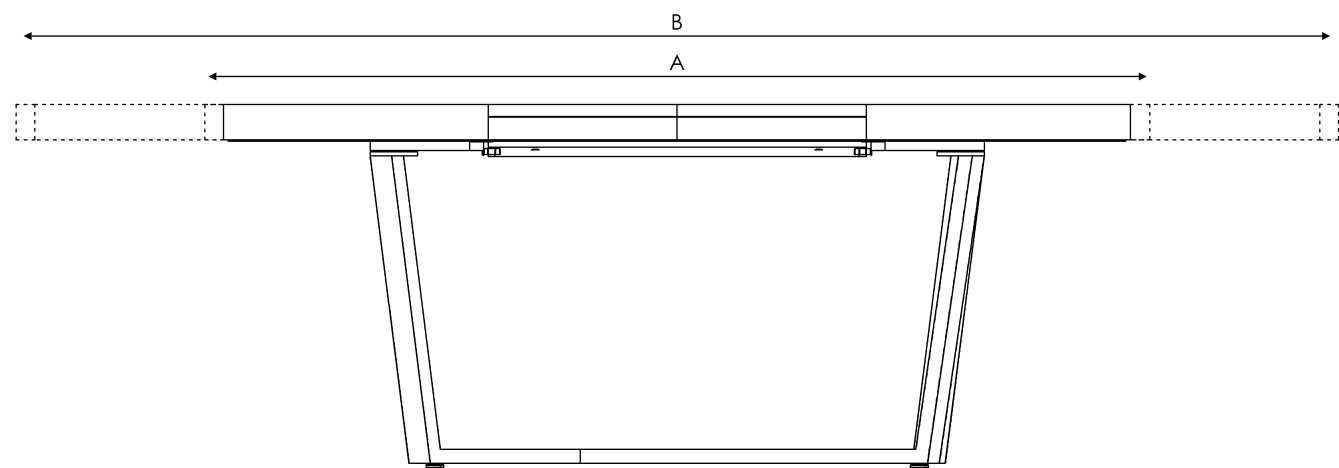

Face | Frente | Front

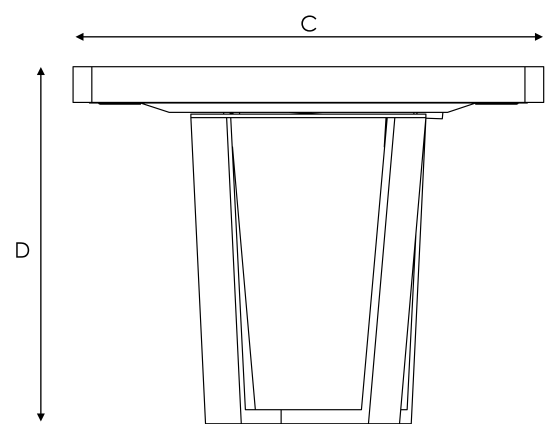

Côté | Lado | Side

Ref.	A	B	C	D
631311	1800	-	1000	770
631312	2000	-	1000	770
631313	2200	-	1000	770
631314	1800	-	1000	770
631315	2000	-	1000	770
631316	2200	-	1000	770
631317	1800	-	1100	770
631318	2000	-	1100	770
631319	2200	-	1100	770
631320	1800	-	1100	770
631321	2000	-	1100	770
631322	2200	-	1100	770
631324	1800	2600	1000	770
631325	2000	2800	1000	770
631326	2200	3000	1000	770
631327	1800	2600	1000	770
631328	2000	2800	1000	770
631329	2200	3000	1000	770
631330	1800	2600	1100	770
631331	2000	2800	1100	770
631332	2200	3000	1100	770
631333	1800	2600	1100	770
631334	2000	2800	1100	770
631335	2200	3000	1100	770



Travessa da Agra, 34
Frazão 4595-087

Paços de Ferreira – Porto – Portugal

Tel: +351 255 890 250 | Fax: +351 255 890 259

www.animovel.pt | e-mail: info@animovel.pt

animovel
-TECHNIK-



UNIÃO EUROPEIA
Fundo Europeu
de Desenvolvimento Regional